

tebis KNX, building automation
your winning choice

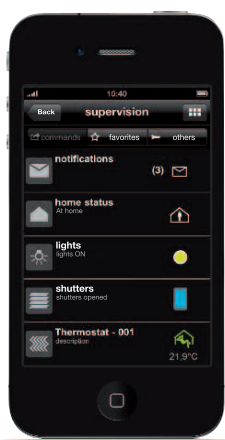

Building automation, a concept in tune with

Connected,
anytime, anywhere!



Who could have imagined just 10 years ago, that one day we would be carrying our music, our photos and our e-mails in our pockets?

Today, we contact our relatives with a single click and we surf unrestrictedly on the web, in the train or on the beach. Smartphones and digital tablets have become our digital alter egos.

They have also become the link to our home. We can visualise what is occurring and its management is at our fingertips.



We are all senior citizens of the future



By 2050, the number of older persons in the world will exceed the number of young for the first time in history. In light of this, institutions are taking the necessary measures to encourage home support. Moreover, we are going to be living better and longer at home; as long as housing is able to constantly adapt to its inhabitants !

In this sense, an electrical installation that is able to evolve is a real asset: adding functions, adapting the control, promoting communication, etc.

the times

Why choose building automation?



Energy performance: an issue in the short term

During 2012 Climate Change Conference in Doha, Qatar, the United Nations committed to reduce greenhouse gases emissions by at least 18% below 1990 levels from 2013 to 2020. Buildings represent 40% of total primary energy consumption.

To reduce our dependence in fossil fuels and limit our energy consumption in the coming

years, we need to design and construct high-performance buildings, motivating building owner and user to save energy. A real challenge for the industry.

The technology to achieve these goals already exists!

While most of these technologies have a passive role, in contrast the electrical

installation is a driving element in managing energy performance in housing. Through solutions such as energy dashboards, home automation systems and automatic management of lighting and heating, it is possible to influence energy consumption actively and significantly.

Building automation, a business generator

Front page news

With the focus on energy efficiency and home support, building automation is becoming a component in its own right for many projects. Quite rightly, the media has seized on this topic and aroused public interest in the solutions. Architects, interior designers and individuals are keen to find information and are approaching manufacturers and installers.

Capitalise on your know-how

Choosing building automation is to access a higher level of electrical installation. Using original and custom functions, you can capitalise on your know-how and enhance your proposals to distinguish yourself from your competitors.

Customer loyalty

The lifestyle of your customers changes regularly. With building automation, it is easy to adapt their homes to their changing needs. Take advantage of these readily available opportunities to demonstrate new functionality or control interfaces to your customers.

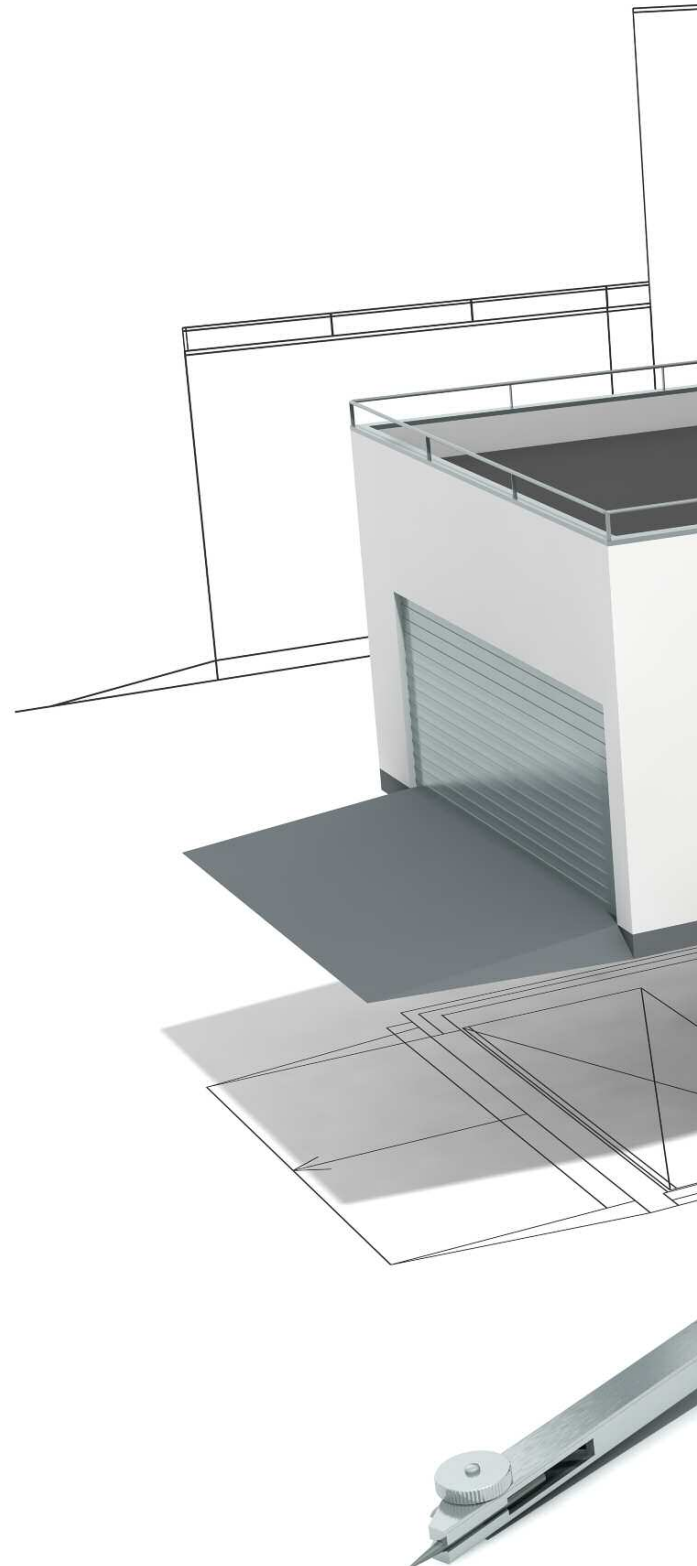

Why choose building automation?



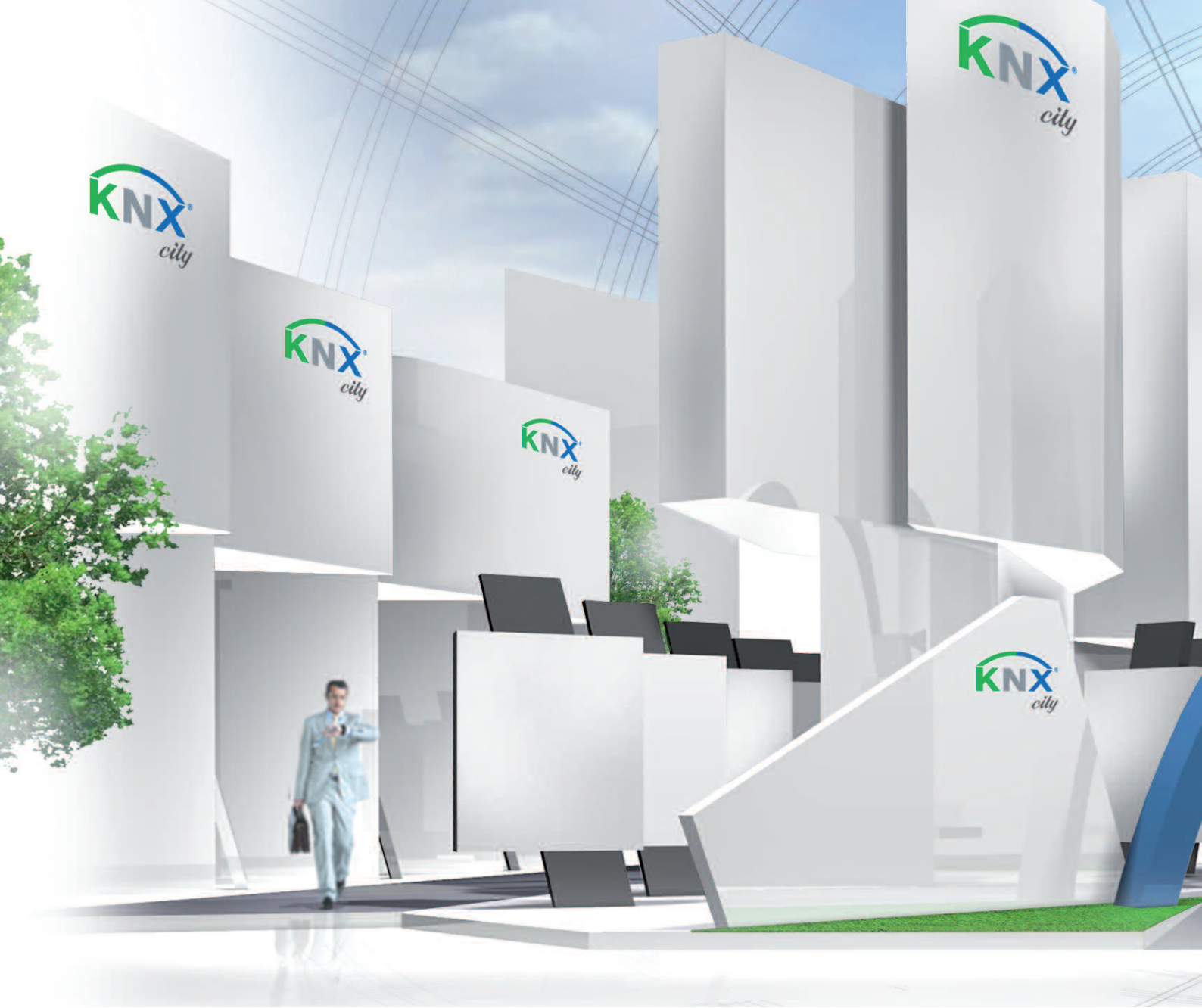

KNX, the strength of a standard

70%

of the home
automation
market*

300

manufacturers

7000

products

* in Europe (BSRIA study, May 2012)



KNX, the
obvious
choice

Guaranteed compatibility

For over 20 years, the presence of the KNX logo on products has certified that they communicate perfectly with each other, even when they are offered by different manufacturers. This ensures a high degree of flexibility in the extension and modification of facilities.

Seamless continuity

The extent of the KNX community gives the protocol a unique power in the home automation market. Its broad range of products constitutes a set of solutions to meet all situations.

Openness, a state of mind

Various gateways are offered by the adherents of KNX to create links with other specification standards such as DALI and BACNET.

The architecture of a KNX automation installation: flexibility and scalability

The architecture of a KNX building automation installation is based on an original principle, separation of the power and control circuits. This approach provides a distinct advantage: the possibility to change the installation at any time.

Modify and enrich

Unlike traditional systems, a KNX installation does not physically link the control with the function. All the controls are grouped on the bus (wired or wireless).

The goal is to release the potential restricted by command/function association.

Changing the configuration or adding new control points is then achieved simply and without additional work.

The benefits:

- time savings
- scalability of installations without additional work

Integrating linked universes

In a KNX installation, other features such as intrusion and technical alarms, video surveillance, multi-room functions, videophones or even home maintenance systems can be easily integrated via dedicated gateways.

The benefits:

- enrichment of capabilities
- access to other markets
- business development



building

KNX,
the obvious
choice





Comfort
applications

Control your installation at your fingertips

With domovea, everything in the installation can be managed from one single point. Available on computer, tablet or smartphone, this intuitive interface provides easy control of any device. You can control central applications like roller shutters or lighting for each room, each floor or for the entire building.



Advantages

- Central functions to control lights or shutters at your fingertips
- Call up complex sequences directly from the dashboard
- One interface for all devices: the same design is adapted for the best user experience on smartphone, tablet or computer



Did you say easy?

Requiring only 6 modular units on the DIN rail, you just need to install tebis KNX domovea server to make KNX and IP worlds connected. Then, import your KNX project directly from ETS and get the user interface ready for operation within 10 minutes!

You can even create sequences and time functions directly from domovea configuration software.

Comfort applications



Giving the final touch to your installation with domovea for tablets

It is so easy to get the domovea application on your own tablet. Thanks to the Wi-Fi connection, the application loads automatically and gives you access to the control of the devices in your home.

Programm yourself the automation for more comfort. For example, you can ask domovea to automatically open the shutters at 7 o'clock and enable the alarm at 10.00 from Monday to Friday. Save even more time for your other activities !

Available for:

- Windows tablets (Windows 8)
- Apple tablets
- Android tablets



Monthly temperature overview display on tablet.

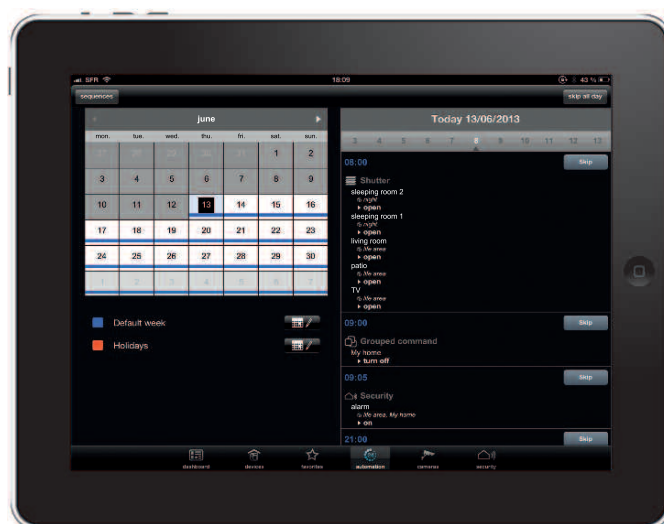

Programm your home devices on your tablet.

Key Products

domovea server TJA450

Number of modules: 6
Power supply: 24 V DC
Connections: KNX connectors
3x USB 2.0, Type A Jack
RJ45 Connection
quickconnect

Configuration software and client on supplied USB memory stick



domovea system package TJA451

Consisting of: - TJA450 domovea server with remote access
- TGA200 power supply

For configuration of domovea in a KNX/IP environment.

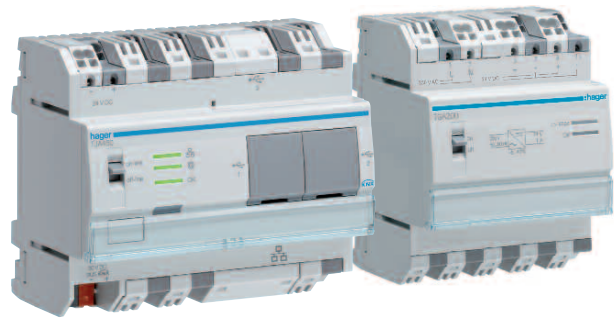

domovea apps

The iOS application for iPhone, iPod and iPad can be found using the search term domovea and downloaded from the Apple App Store.

The Android-App can be downloaded from the Android Market





Flexibility applications

Ready for the future

Electrical installation is built to last. But users expectations are changing constantly. In a house, would you like to change a former bedroom into a home office, you need to relocate lights and switches. In office building, you regularly need to adapt the space configuration to your organisation.

Just do it: tebis KNX gives you the required flexibility!

Without any new cabling or heavy works, you just need to change the KNX configuration to make the installation fitting to these new requirements.

And thanks to radio frequency devices, you can add new KNX switches anywhere.



Advantages

- Total flexibility in the configuration, ideal for office buildings.
- No cabling constraint with RF KNX switches, especially adapted to glass surface.



Even more functions?

Building automation system grows with its tasks! Using the relevant tebis KNX products, additional functions can be integrated into the installation - e.g. a weather station, individual room temperature controllers or dimmers. Take this opportunity to come back to your customers to upgrade the installation!

Flexibility applications



Combining Radio Frequency with BUS KNX for more flexibility

RF media coupler makes the link between RF devices – up to 24 devices – and BUS KNX for easy installation without cabling. Ideal for retrofit, RF devices can be also used to install products on a specific surface like glass.

Principle of operation:

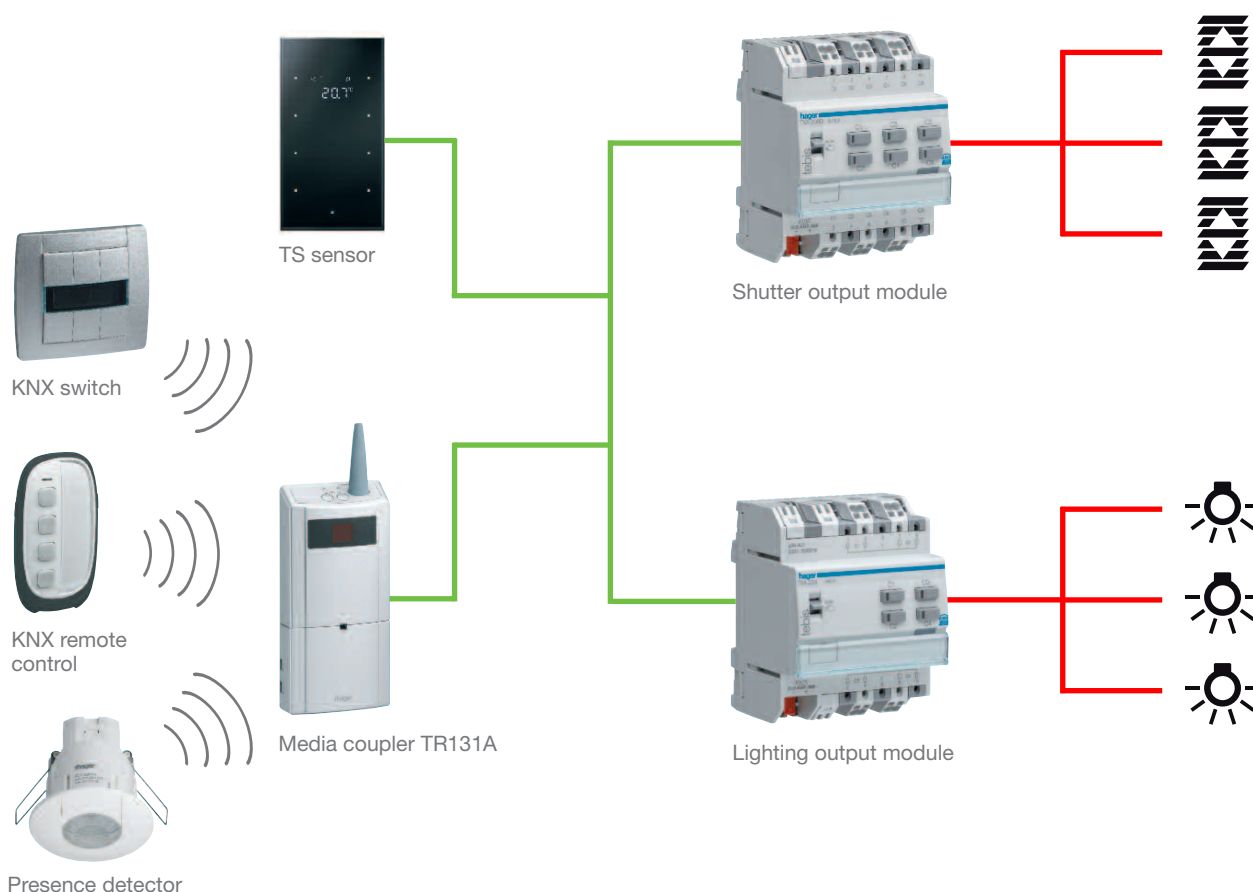

Key Products

Media coupler TR131B

Allows the transmission of messages from “bus” products to radio products and vice versa.

supply voltage: bus 30V DC

transmission frequency: 868,3 MHz



RF Unidirectional input concentration TR351A

Increases the number of unidirectional radio products in a combined system (radio/wired-based) by grouping together the inputs that perform the same function.

supply voltage: 230V AC bus / bus 30V DC

transmission frequency: 868,3 MHz



Repeater TR140B

Repeats orders when communication between radio product breaks down due to excessive signal loss.

supply voltage: 230V AC 50Hz ± 15%

transmission frequency: 868,3 MHz



Mobility applications

Keep contact with your home

We live in a connected world – internet is everywhere, carrying all kind of services at your disposal. Why should your home be an exception? Today you can keep contact with your home with secured access to check if all lights are switched off or control the temperature.

And with IP cameras you can even keep an eye on your home when you are away!



Advantages

- Secured internet portal for remote access from any device
- Dedicated domovea applications for tablets and smartphones running on Android and iOS (Apple)
- Up to 10 IP cameras to monitor your home



Even more services?

Coupled to relevant services and monitoring solutions, tebis KNX brings new perspectives for ambient assisted living. IP cameras will support monitoring services to be more accurate and avoid false alerts, for example.



Providing remote access to building automation via domovea server

Thanks to domovea portal, you can control your KNX installation from the web browser on any device or from Apple and Android application. As soon as you are back home, the connection switches automatically on local wireless.

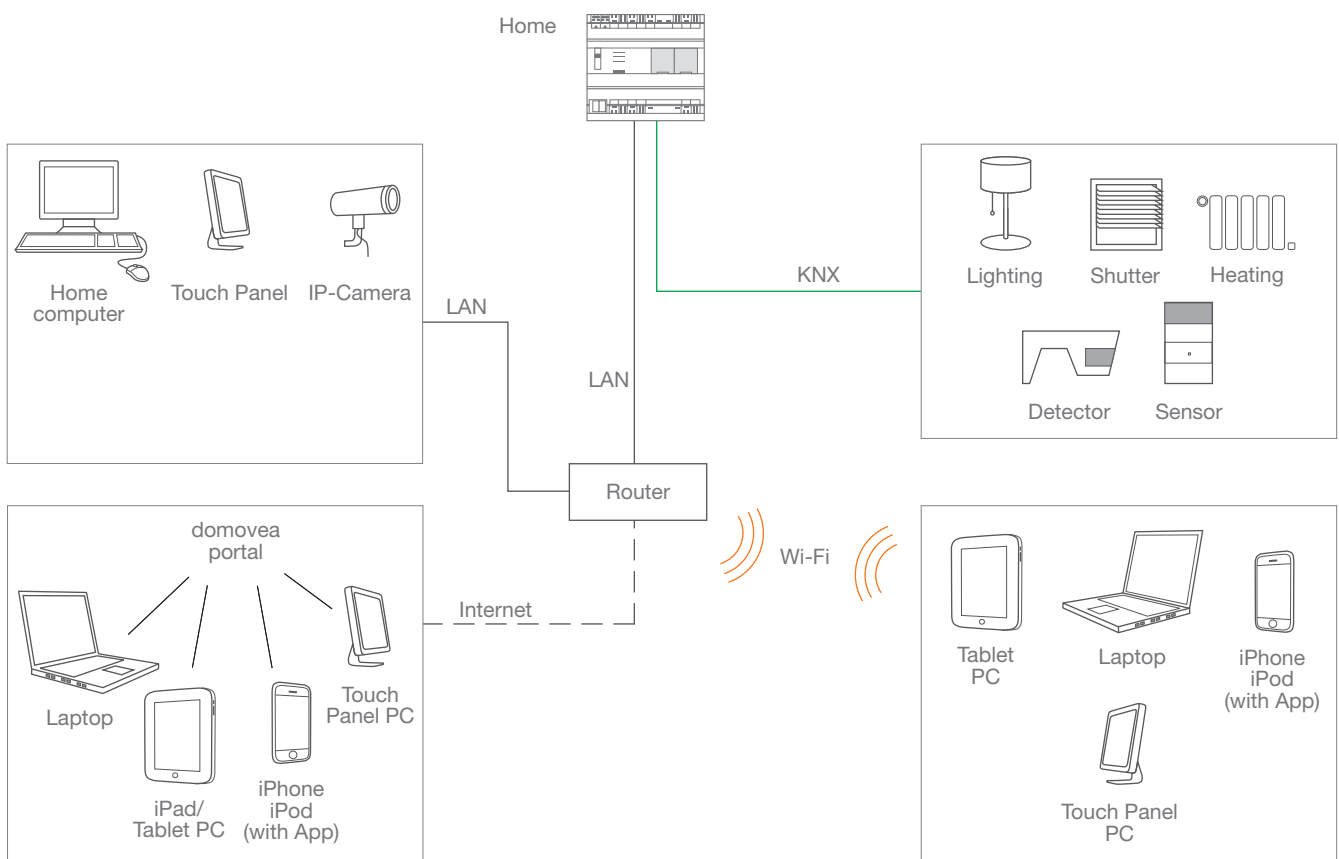

Key Products

domovea remote access TJ550 (integrated in package TJ451)

- domovea portal:

Remote access to the domovea server via the secure Hager Internet portal (www.domovea.com)

License key supplied on a USB memory stick

The possibility to access the KNX project externally using an Internet browser or domovea iPhone App (not included in the supply)

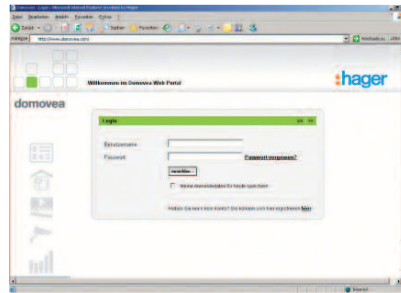

domovea apps

The iOS application for iPhone, iPod and iPad can be found using the search term domovea and downloaded from the Apple App Store.

The Android-App can be downloaded from the Android Market





Energy-efficient applications

Save without thinking

Often, it is the small actions that result in savings: turning off an unused light, closing the shutters at night, etc.

You no longer need to think about it, your building automation system is in control. From a specified time or in response to the sunset, it switches your home to economy mode.



Advantages

- Avoid leaving unnecessary lights switched on.
- Avoid heat loss from the house during the night.
- Open the shutters to enjoy the morning sun.



Still more savings?

- Install timer switches in passageways (corridors, stairs) and storage rooms (cellar, laundry).
- Vary the energy saving lamps (CFL and LED).

Energy-efficient applications



Programming the switching off of lighting circuits and closing of shutters

Principle of operation

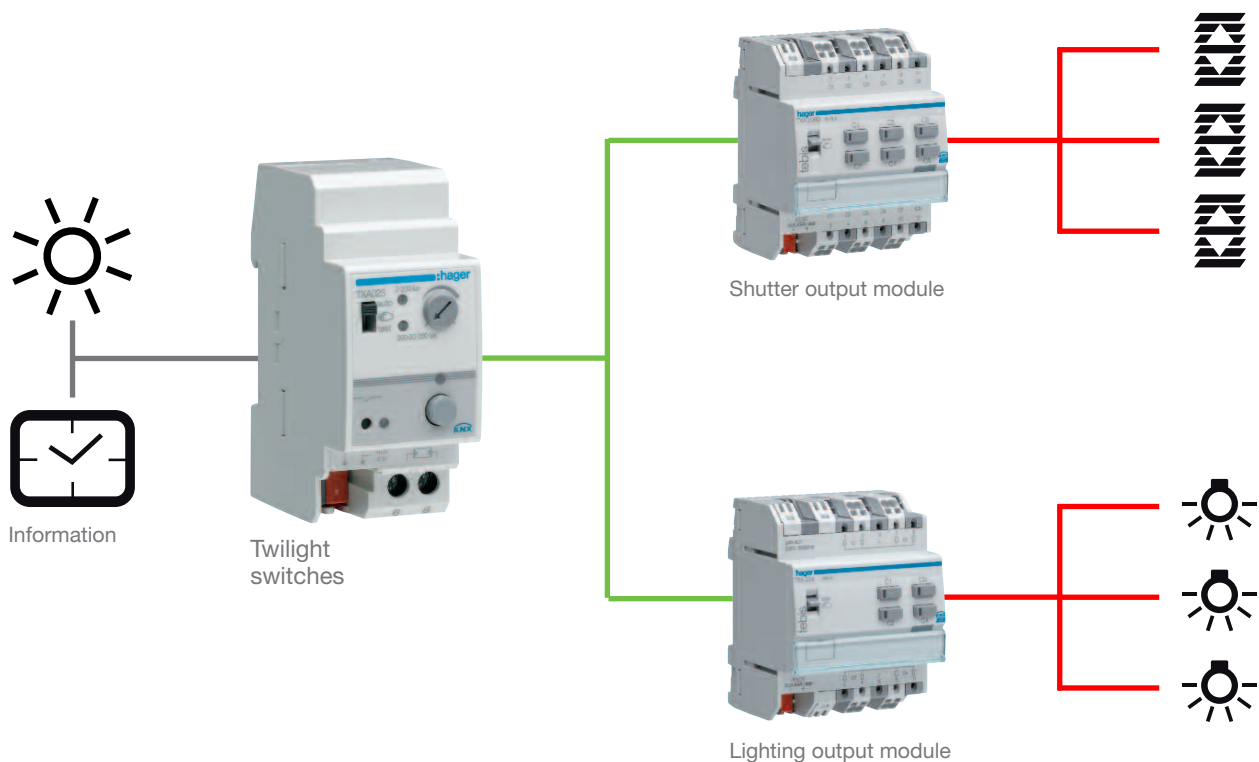

Key Products

Twilight switch TXA025

Number of modules:	2
Number of channels:	1
Sensors to link:	EE002 - EE003
Luminosity measurement range:	2 to 20,000 Lux
Maximum sensor connection distance:	100 m



Timer switch TXA023

Number of modules:	2
Number of channels:	2
Number of programming steps:	56
Time switch type:	electronic
Power reserve:	lithium battery





Energy-
efficient
applications

Beyond building design

Energy efficiency is not only a matter of building design, but also a question of behaviour of the user. With its energy dashboard, domovea educates occupants to optimise their consumption. For its part, the building manager possesses a management tool to optimise operating costs.



Advantages

- Motivates the user to optimize energy consumption
- Provides a solution for building overall supervision

Even more services?

Centralising the data from each housing unit on a common server:

- Facilitates the sharing of costs between housing units.
- Reduces the bill for home automation installation.

Energy-efficient applications



Pooling building automation services over an entire building

Installed in each apartment, the consumption indicator TE330 KNX is the metering unit for power consumption. It feeds data to the domovea energy dashboard.

Using a single TJA450 domovea server, it is possible to centralise all the data from the apartments for better individual and overall management.

Principle of operation

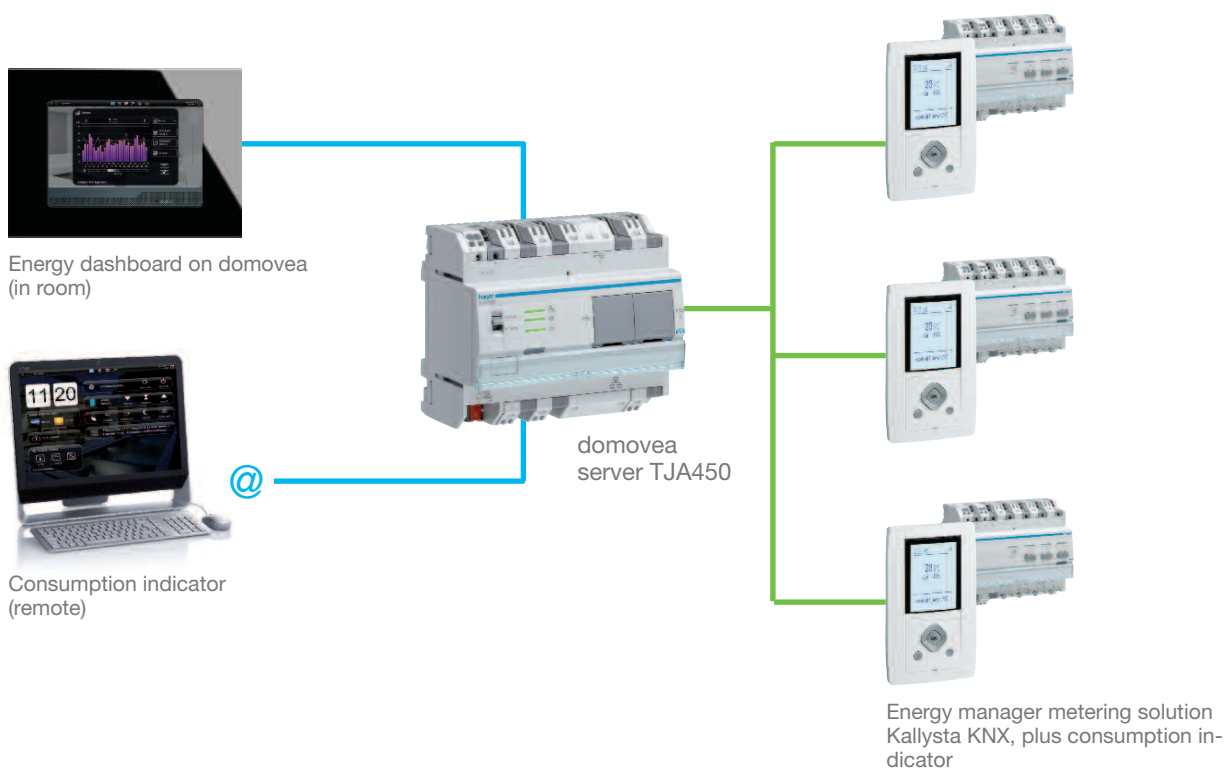

Key products

Consumption indicator KNX TE330

KNX supports:

Wired bus
(and radio via a coupler)

Metering:

- 3-way sub-metering
- meter report, tariff information by tele-information

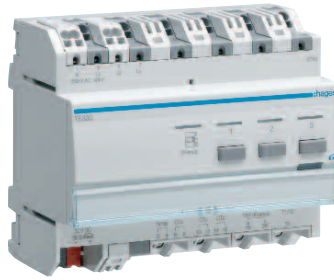

domovea software

Visualisation of consumption:

- Instantaneous, daily, cumulative or based on a reference period (expressed in watts and/or euro).
- The whole house, room by room or even item by item (heating, lighting, household appliances, etc.).
- Supports the various subscriptions ("blue" tariff, "tempo" tariff, etc.).

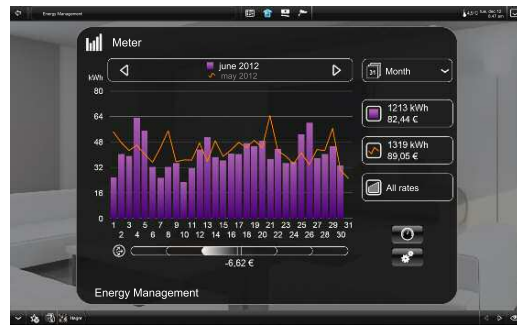



Security
application

Departing with peace of mind

Close the shutters and garage doors and activate your alarm, all from a single button...
Being sure that the house is safe.



Advantages

- Save time when leaving the house.
- Have a single remote control for several functions.
- Be sure that you have not forgotten anything.



Even more comfort?

- Complete your installation with a motion detector (TRE500) to link with the outdoor lighting.
- Schedule lighting to be sure not to forget it.
- Create a different scenario for arrival and departure.

Security application

Group the building automation commands and alarm together on a single device

Because it is a dual-protocol device, the TU444 remote can control both an alarm system and a tebis installation. The communication is made via the TR131B media coupler for wired sections. The transition from one function to another is accomplished easily, using the side keys.

Principle of operation

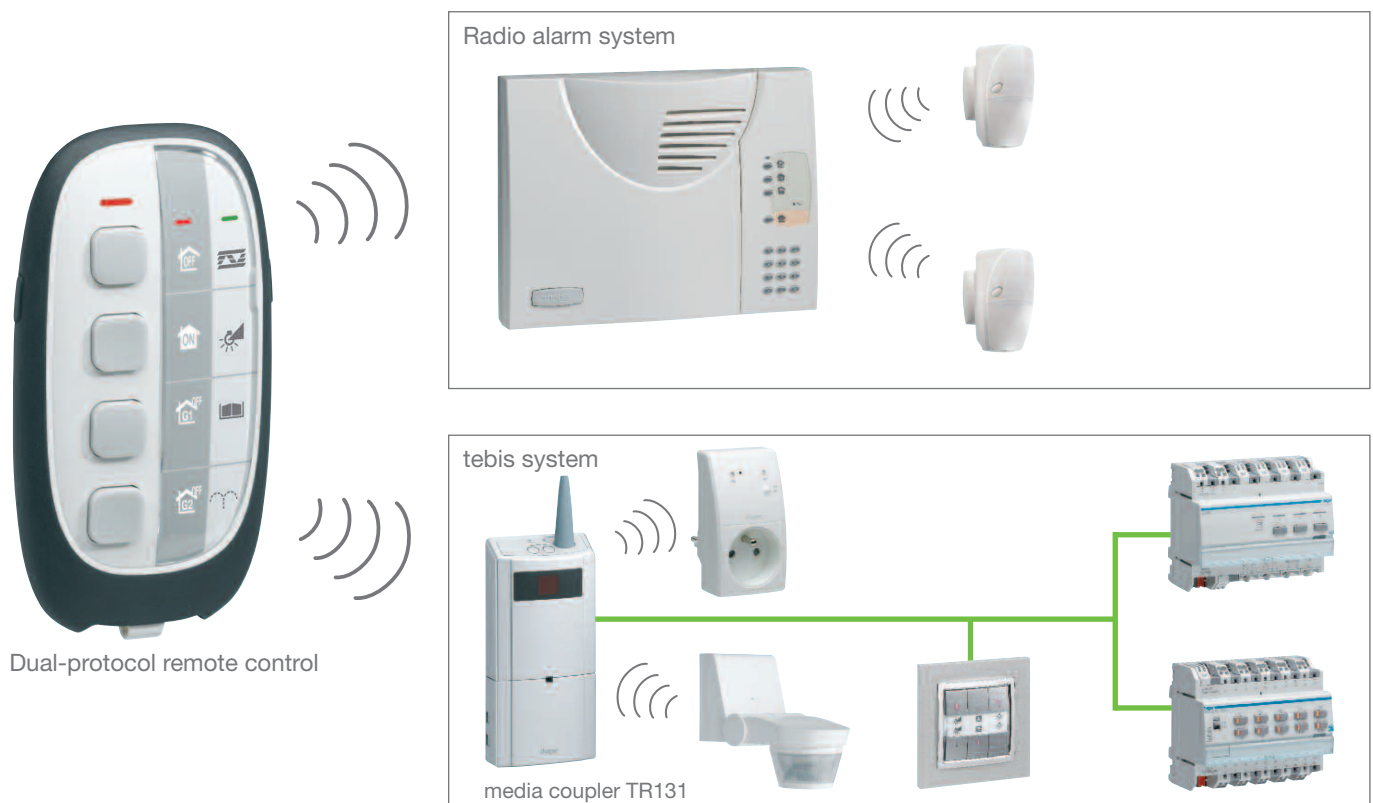

Key products

Dual-protocol remote control TU444

Number of buttons:	4
Protocols:	KNX, RF and TwinBand
Number of channels:	8, including 4 for alarms and 4 for KNX (toggle by pressing the buttons on the side)
Advanced functions:	Ability to link a KNX command to an alarm control



4-group alarm pack SK304-22F

Connection mode:	Radio TwinBand and tebis.quicklink
Autonomy:	5 years
Composition of the kit:	- 1 controller S304-22F - 2 motion sensors LS, radio, 90 °, 12 m, S161-22F - 2 remote controls TU444, radio alarm and radio tebis.quicklink



Security application

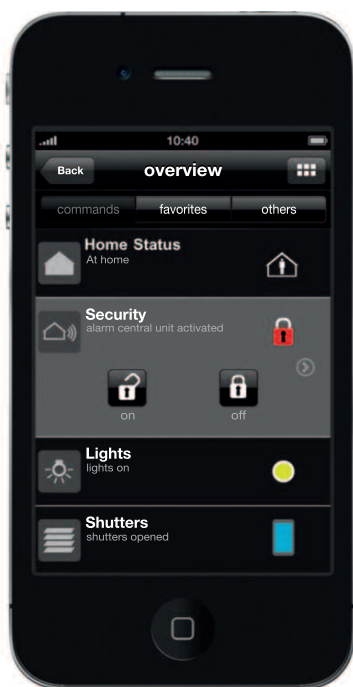
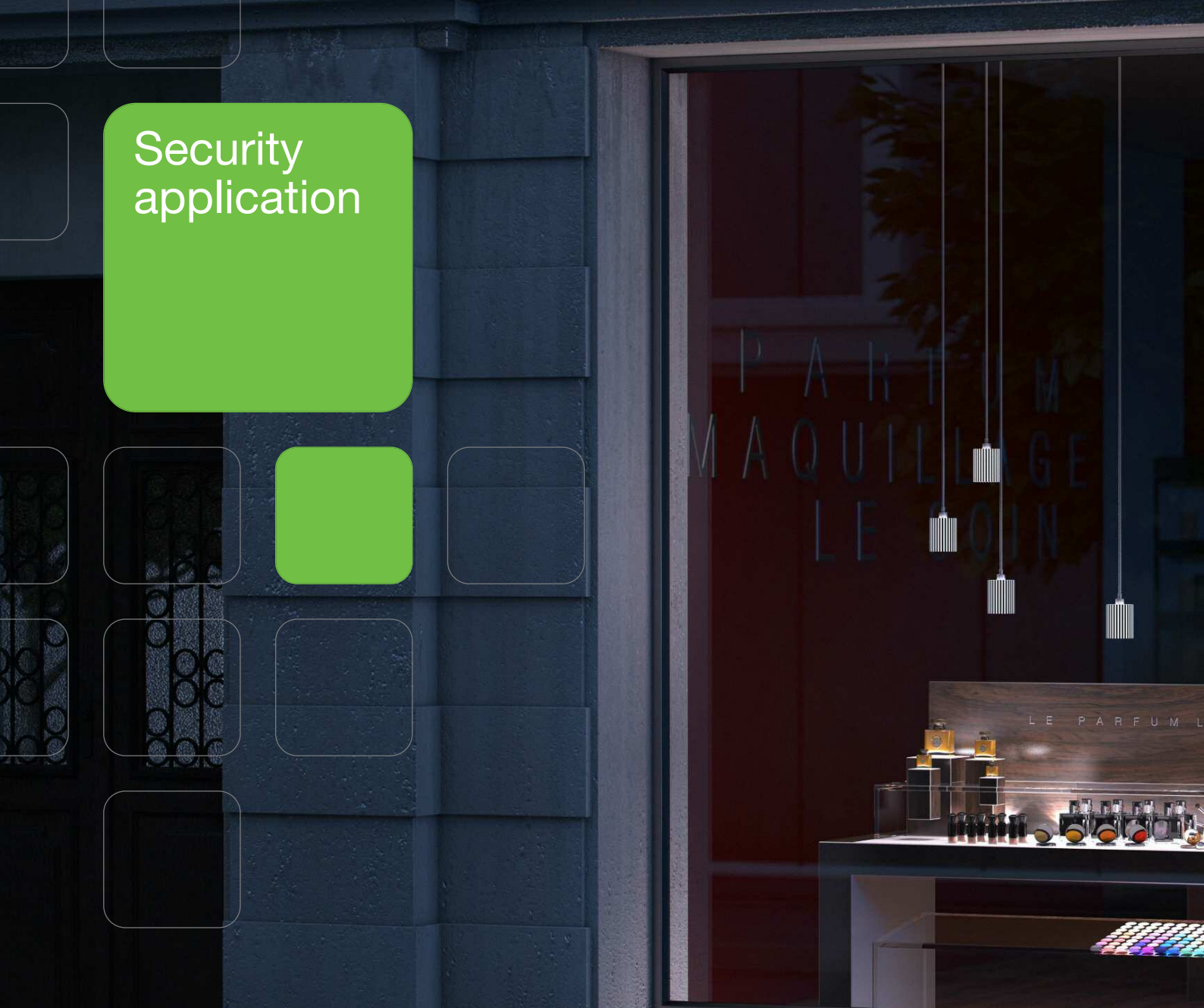

Be warned of an intrusion

An intrusion is detected in your store! Instantly, the information is sent to you by e-mail. Via your Smartphone, you can see the action...

Phew, don't worry, it is only the cleaning service that has not disabled the alarm by entering.



Advantages

- Real-time information.
- Removal of doubt (via IP camera).
- Remote control.

Even more peace of mind?

Creating a home automation intrusion scenario:

- Turn on all the lights.
- Close shutters and screens.
- Automatically lock secure areas (motorised door strikes ...)

Security application



Initiating building automation actions in response to an alarm

The association of a building automation system with an alarm system amplifies the functional value of each. Thanks to the TRC120 gateway, it is possible to integrate information from the alarm system with home automation actions.

Principle of operation

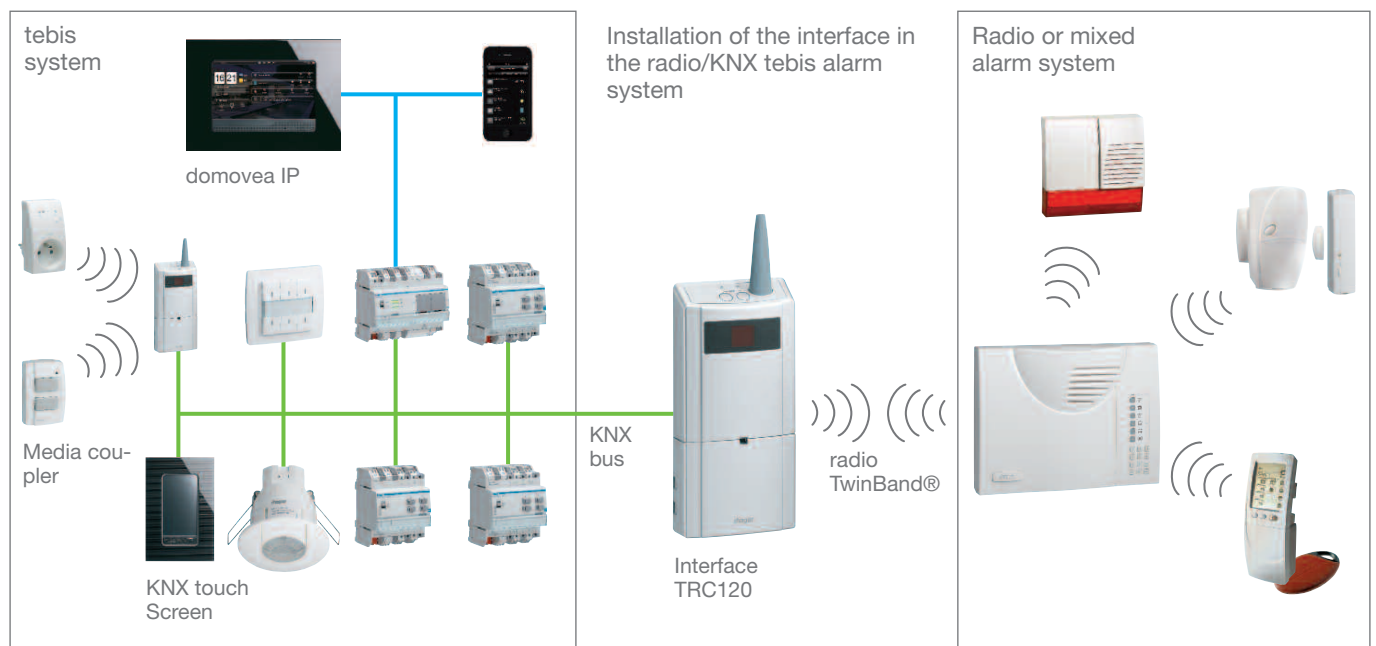

Key products

KNX gateway/alarm TRC120

KNX supports:	Wired bus
Support alarm:	RF TwinBand protocol
tebis action on alarm:	Switch on: total, partial Alert: intrusion, silent
Alarm action on tebis:	- Reporting of all alarms - Possibility of tebis action on alarm
With domovea:	- Global visualisation of the system - Commands (via secure coded keypad): general, groups - Event notification (1st level) - Integration into sequences: sending e-mail on events



domovea server TJA450

Number of modules:	6
Application:	domovea server
Interface type:	Other



Berker by Hager

each project has its style

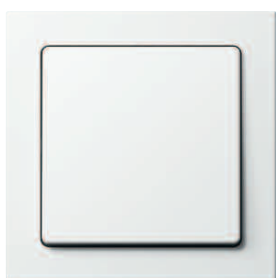

Q.3



K.1



K.5



B.7



B.IQ



TS sensor

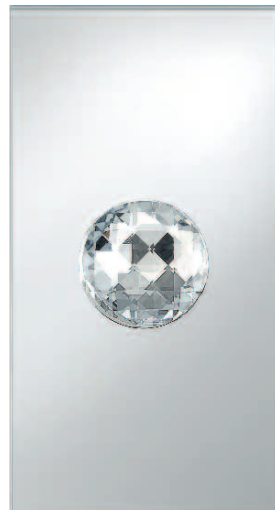

Crystal ball

and so much more ...



domovea, the dashboard of your home

Equipped with new functions such as Sequence and Remote access, domovea gives you easy control of your home through software control and user friendly visualisation.



"App to date" - with the iPhone and iPad app

The new domovea, iPhone and iPad App can be downloaded from the Apple App Store. It allows both local operation via the house network, as well as external control via the Internet. The domovea application is also available for Android phones on Android Market.



Comfort at your fingertips

The quality of a home automation system is judged primarily by the benefits it brings to its users. In terms of comfort, offering several solutions to control the home automation functionality of a house is an asset. Stay connected with your home when you are outside.

Your media centre for audio and video

Mutualize and control your multimedia devices from a single point: manage your home cinema installation, music and radio from any source (DVD, hi-fi, tuner, computer...). With appropriate KNX gateway, you can display and control the sound as you like in the whole house.



A window in your home...

Ergonomics and design were well thought of in domovea to help you control your home automation system. Launch of sequences at any time from anywhere enables you to control your home even being not at home.

Via secure portal of www.domovea.com you can turn off lights remained lit or you can view different locations of your home through IP cameras. You can trigger a predefined schedule at predefined time or at your wish.

Project references by Hager

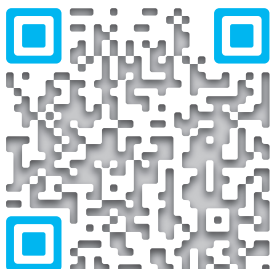

Hager: a strong reference, worldwide knowledge

As a partner providing in smart products and solutions for commercial premises and housing, Customers are trusting us all around the world.

You can have a look at our international reference book online and appreciate the solutions Hager can bring to your project.

www.africa.hager.com/bs/project_references

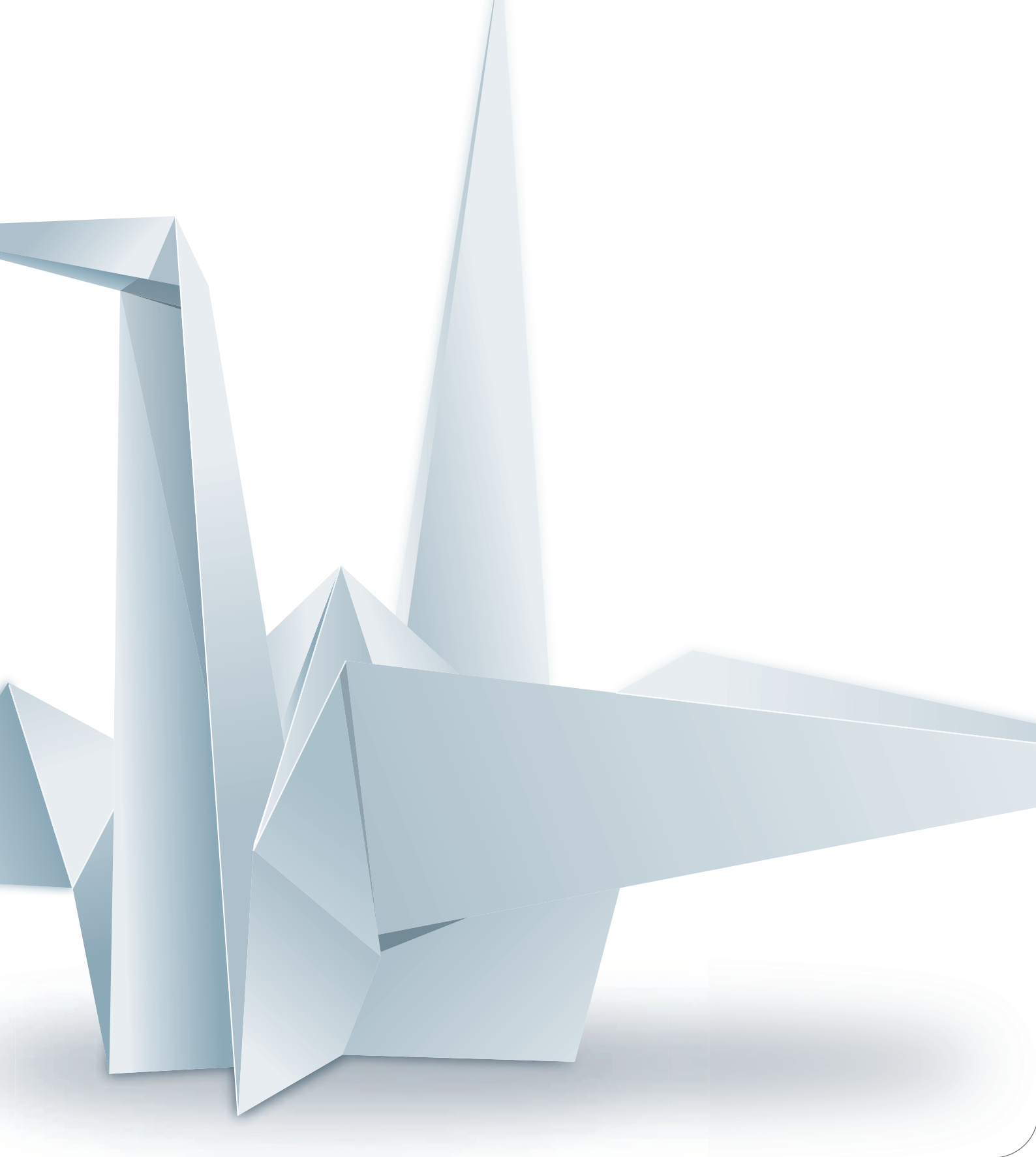

:hager

Hager Electro S.A.S.
132, boulevard d'Europe
B.P.3
67215 Obernai cedex
France
www.hager.com

